



**4/8-Port HDMI over single Cat 5 Splitter
VS1814T / VS1818T
User Manual**



www.aten.com

FCC Information

FEDERAL COMMUNICATIONS COMMISSION INTERFERENCE STATEMENT

This equipment has been tested and found to comply with the limits for a Class A digital device, pursuant to Part 15 of the FCC Rules. These limits are designed to provide reasonable protection against harmful interference when the equipment is operated in a commercial environment. This equipment generates, uses, and can radiate radio frequency energy and, if not installed and used in accordance with the instruction manual, may cause harmful interference to radio communications. Operation of this equipment in a residential area is likely to cause harmful interference in which case the user will be required to correct the interference at his own expense.

FCC Caution: Any changes or modifications not expressly approved by the party responsible for compliance could void the user's authority to operate this equipment.

CE Warning:

This is a class A product. In a domestic environment this product may cause radio interference in which case the user may be required to take adequate measures.

RoHS

This product is RoHS compliant.

SJ/T 11364-2006

The following contains information that relates to China.

部件名称	有毒有害物质或元素					
	铅	汞	镉	六价铬	多溴联苯	多溴二苯醚
电器部件	●	○	○	○	○	○
机构部件	○	○	○	○	○	○

- : 表示该有毒有害物质在该部件所有均质材料中的含量均在SJ/T 11363-2006规定的限量要求之下。
- : 表示符合欧盟的豁免条款, 但该有毒有害物质至少在该部件的某一均质材料中的含量超出SJ/T 11363-2006的限量要求。
- ×: 表示该有毒有害物质至少在该部件的某一均质材料中的含量超出SJ/T 11363-2006的限量要求。



User Information

Online Registration

Be sure to register your product at our online support center:

International	http://eservice.aten.com
---------------	---

Telephone Support

For telephone support, call this number:

International	886-2-8692-6959
China	86-10-5255-0110
Japan	81-3-5615-5811
Korea	82-2-467-6789
North America	1-888-999-ATEN ext 4988
United Kingdom	44-8-4481-58923

User Notice

All information, documentation, and specifications contained in this manual are subject to change without prior notification by the manufacturer. The manufacturer makes no representations or warranties, either expressed or implied, with respect to the contents hereof and specifically disclaims any warranties as to merchantability or fitness for any particular purpose. Any of the manufacturer's software described in this manual is sold or licensed *as is*. Should the programs prove defective following their purchase, the buyer (and not the manufacturer, its distributor, or its dealer), assumes the entire cost of all necessary servicing, repair and any incidental or consequential damages resulting from any defect in the software.

The manufacturer of this system is not responsible for any radio and/or TV interference caused by unauthorized modifications to this device. It is the responsibility of the user to correct such interference.

The manufacturer is not responsible for any damage incurred in the operation of this system if the correct operational voltage setting was not selected prior to operation. PLEASE VERIFY THAT THE VOLTAGE SETTING IS CORRECT BEFORE USE.

Package Contents

The VS1814T / VS1818T 4/8-Port HDMI over single Cat 5 Splitter package consists of:

- ◆ 1 VS1814T / VS1818T 4/8-Port HDMI over single Cat 5 Splitter
- ◆ 1 Power Cord
- ◆ 1 Mounting Kit
- ◆ 1 User Instructions*

Check to make sure that all the components are present and that nothing got damaged in shipping. If you encounter a problem, contact your dealer.

Read this manual thoroughly and follow the installation and operation procedures carefully to prevent any damage to the unit, and/or any of the devices connected to it.

* Features may have been added to the VS1814T / VS1818T since this manual was printed. Please visit our website to download the most up-to-date version.

© Copyright 2014 ATEN® International Co., Ltd.
Manual Date: 2014-04-30

ATEN and the ATEN logo are registered trademarks of ATEN International Co., Ltd. All rights reserved.
All other brand names and trademarks are the registered property of their respective owners.

Contents

FCC Information	ii
RoHS	ii
SJ/T 11364-2006	ii
User Information	iii
Online Registration	iii
Telephone Support	iii
User Notice	iii
Package Contents	iv
Contents	v
About this Manual	vii
Conventions	viii
Product Information	viii
1. Introduction	
Overview	1
Features	2
Requirements	3
Source Device	3
Receiving Device	3
Cables	3
Components	4
Front View	4
Rear View	5
2. Hardware Setup	
Rack Mounting	7
Grounding	9
Installation	10
3. Operation	
Overview	11
EDID Learn Pushbutton	11
EDID Mode Selection	12
Installing the RS-232 Controller	12
4. RS-232 Commands	
Overview	13
RS-232 Serial Interface	13
Configuring the Serial Port	13
Switch Port	14
CEC Commands	15
Read Commands	16
Baud Rate Setting Commands	17
Reset Commands	18
Verification	18

Appendix

Safety Instructions	19
General	19
Rack Mounting	21
Technical Support	22
International	22
North America	22
Specifications	23
Limited Warranty	24

About this Manual

This User Manual is provided to help you get the most from your VS1814T / VS1818T system. It covers all aspects of installation, configuration and operation. An overview of the information found in the manual is provided below.

Introduction, introduces you to the VS1814T / VS1818T system. Its purpose, features and benefits are presented, and its front and back panel components are described.

Hardware Setup, describes how to set up your VS1814T / VS1818T installation. The necessary steps are provided.

Operation, explains the fundamental concepts involved in operating the VS1814T / VS1818T through the RS-232 serial interface.

An Appendix, provides specifications and other technical information regarding the VS1814T / VS1818T.

Conventions

This manual uses the following conventions:

- Monospaced Indicates text that you should key in.
- [] Indicates keys you should press. For example, [Enter] means to press the **Enter** key. If keys need to be chorded, they appear together in the same bracket with a plus sign between them: [Ctrl+Alt].
1. Numbered lists represent procedures with sequential steps.
- ◆ Bullet lists provide information, but do not involve sequential steps.
- Indicates selecting the option (on a menu or dialog box, for example), that comes next. For example, Start → Run means to open the *Start* menu, and then select *Run*.
-  Indicates critical information.

Product Information

For information about all ATEN products and how they can help you connect without limits, visit ATEN on the Web or contact an ATEN Authorized Reseller. Visit ATEN on the Web for a list of locations and telephone numbers:

International	http://www.aten.com
North America	http://www.aten-usa.com

Chapter 1

Introduction

Overview

The ATEN VS1814T / VS1818T 4/8-Port HDMI over single Cat 5 Splitter is a fast and efficient way of switching digital high definition video from one input source to 4/8 displays located up to 100m away. It implements HDBaseT extension technology to connect the VS1814T / VS1818T to receiver units over one single Cat 5e cable in order to transmit rich HDMI multimedia content in real time.

You can connect up to 4 (VS1814T) or 8 (VS1818T) HDMI Receivers (such as VE812R) to a unit. The built-in RS-232 port on the VS1814T / VS1818T rear panel allows connected units to be controlled through a high-end controller or PC.

The VS1814T / VS1818T supports up to 4k2k HDTV resolution, as well as up to 1920 x 1200 PC resolution. It is equipped with an EDID selection method, providing constant and reliable EDID data for the HDMI source device to efficiently optimize video resolution.

The VS1814T / VS1818T HDMI Splitter is HDCP (High Bandwidth Digital Content Protection) compliant and compatible with a wide range of ATEN devices (switches, matrix, converters, and so on). It supports all HDMI-enabled equipment, such as DVD players, satellite set-top boxes and all HDMI displays, making it an effective solution in broadcasting applications, digital signage and educational settings.

Features

- ◆ One HDMI input to 4/8 HDMI outputs via a Cat 5e cable
- ◆ Offers local HDMI output
- ◆ Extends displays up to 100 m
- ◆ Anti-jamming – resists signal interference during high-quality video transmissions using HDBaseT technology
- ◆ Implements HDBaseT extension technology using only one Cat 5 cable to connect the transmitter and receiver
- ◆ HDMI (3D, Deep color, 4kx2k); HDCP Compatible
- ◆ Supports Dolby True HD and DTS HD Master Audio
- ◆ Consumer Electronics Control (CEC) support
- ◆ Built-in bi-directional RS-232 serial remote port for high-end system control*
- ◆ Supports resolutions of up to Ultra HD 4kx2k and 1080p Full HD
- ◆ Supports up to 340MHz bandwidth for high performance video
- ◆ Signaling rates up to 3.4 Gbits
- ◆ EDID mode selection
- ◆ Rack-mountable

* The VS1814T / VS1818T AP operation instructions can be downloaded from the ATEN website (www.aten.com).

Requirements

The following equipment is required for a complete VS1814T / VS1818T installation:

Source Device

The following equipment must be installed on any source of HDMI content:

- ◆ HDMI output connector

Receiving Device

- ◆ A local display device with an HDMI input connector
- ◆ An HDMI Receiver (such as VE812R) with an RJ-45 port for each output port you will be installing

Cables

- ◆ Standard HDMI cables for the source device and local display device
- ◆ Cat 5e cables for the HDMI Receivers

-
- Note:**
1. No cables are included in this package. We strongly recommend that you purchase high-quality cables of appropriate lengths since this will affect the quality of the audio and video display. Contact your dealer to purchase the correct cable sets.
 2. A DVI/HDMI adapter is required when connecting to a DVI source or display device. If a DVI/HDMI adapter is used, audio is not supported.
 3. If you wish to utilize the VS1814T / VS1818T's high-end serial controller function, you will also need to purchase an appropriate RS-232 cable. See *Installing the RS-232 Controller*, page 12.
-

Components

Front View

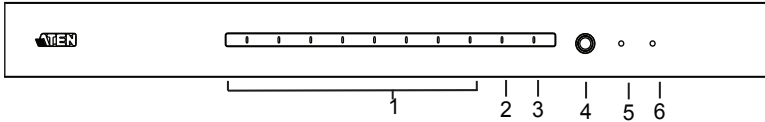

No.	Component	Description
1	HDBaseT Out port LEDs (1~4 / 1~8)	Lights to indicate there is a working connection to the HDMI receiving device(s) connected to the port(s).
2	HDMI Out LED	Lights to indicate there is a working connection to the local display device.
3	HDMI In LED	Lights to indicate that there is a working connection to the source device (i.e., computer).
4	EDID Learn Pushbutton	Press and release this button to automatically learn the active display's EDID.
5	EDID Learn LED	Flashes green to indicate that EDID Learning Mode is in progress (see <i>EDID Learn Pushbutton</i> , page 11). Lights green to indicate that EDID learning process is successful. Lights red to indicate that EDID learning process failed.
6	Power LED	Lights green to indicate that the VS1814T / VS1818T is receiving power and is up and running.

Note: The VS1818T's front panel is shown on this page. It is similar to the front panel of VS1814T except for the number of HDBaseT Out port LEDs – the VS1814T has 4 HDBaseT Out port LEDs.

Rear View

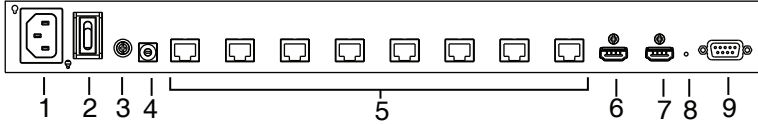

No.	Component	Function
1	Power Socket	This is a standard 3-pin AC power socket. The power cord from an AC source plugs in here.
2	Power Switch	This is a standard rocker switch that powers the unit on and off.
3	Grounding Terminal	The grounding wire attaches here. See <i>Grounding</i> , page 9, for further details.
4	EDID Mode Switch	Press this button to cycle through the EDID settings stored in the unit (see <i>EDID Mode Selection</i> , page 12).
5	HDBaseT Out ports (1~4 / 1~8)	The Cat 5e cables that connects the HDMI Receiver Units plug in here.
6	HDMI Input port	The cable from your HDMI source device plugs in here.
7	HDMI Output port	The cable from your HDMI display device plugs in here.
8	Firmware Upgrade button	This button is for enabling the Firmware Upgrade Mode. Note: Contact your product provider for details on upgrading the firmware of your device.
9	RS-232 Serial Port	This is the serial remote port for output source selection and high-end system control, including firmware upgrade.

Note: The VS1818T's rear panel is shown on this page. It is similar to the rear panel of VS1814T except for the number of HDBaseT Out ports – the VS1814T has 4 HDBaseT Out ports.

This Page Intentionally Left Blank

Chapter 2

Hardware Setup



1. Important safety information regarding the placement of this device is provided on page 19. Please review it before proceeding.
2. Make sure that the power to all devices connected to the installation are turned off.
3. Make sure that all devices you will be installing are properly grounded.

Rack Mounting

For convenience and flexibility, the VS1814T / VS1818T can be mounted on system racks. To rack mount a unit do the following:

1. Using the screws provided in the Rack Mount Kit, screw the mounting bracket into the side of the unit as show in the diagram below:

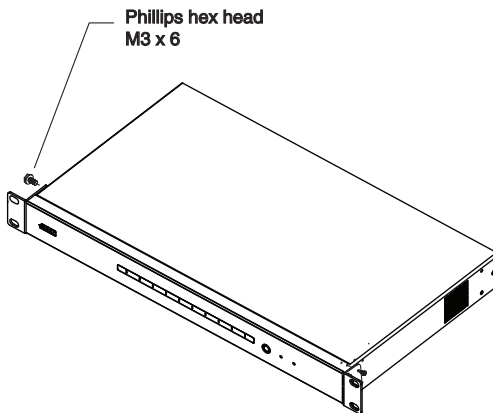

2. Screw the bracket into any convenient location on the rack.

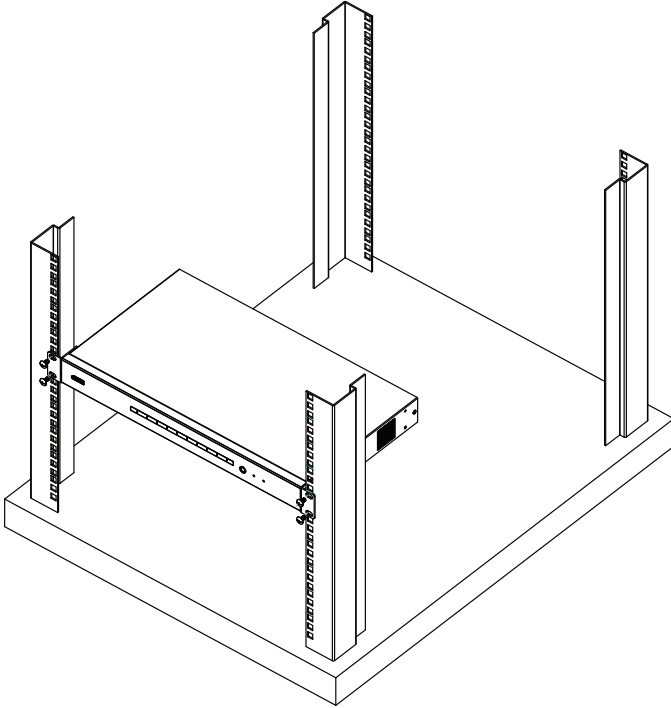

Grounding

To prevent damage to your installation, it is important that all devices are properly grounded.

1. Use a grounding wire to ground the VS1814T / VS1818T by connecting one end of the wire to the grounding terminal, and the other end of the wire to a suitable grounded object.

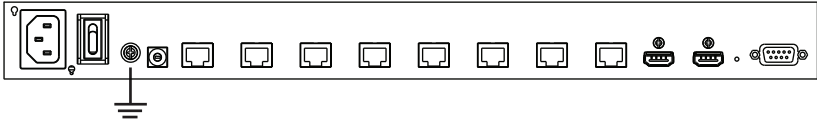

2. Make sure that all devices in your VS1814T / VS1818T installation are properly grounded.

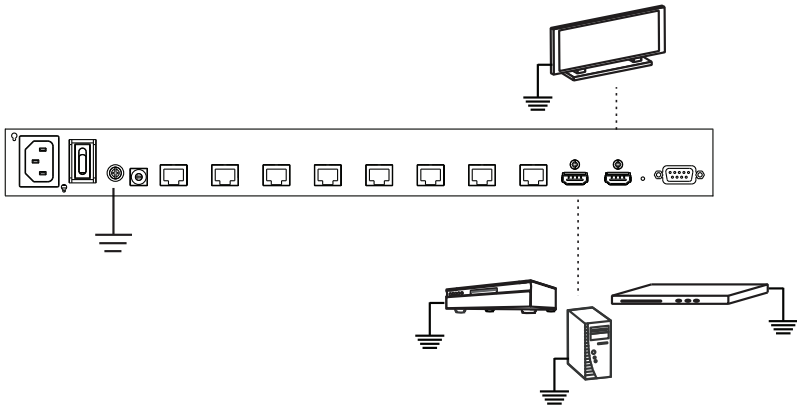

Installation

Refer to the installation diagram (the numbers in the diagram correspond to the numbers of the steps) and do the following:

1. Use an HDMI Type A Male-to-Male cable to connect your computer or HDMI source device to the VS1814T / VS1818T's **HDMI Input** port.
2. Use up to 4 (VS1814T) / 8 (VS1818T) Cat 5e cables to connect up to four / eight HDMI Receiver units (i.e. VE812R) to the **HDBaseT Out** ports.

Note: The HDMI Receiver unit's HDMI OUT port connects to the HDMI IN port on your video display device using an HDMI cable. Refer to your receiving device's User Manual for more details.

3. (Optional) Use an HDMI Type A Male-to-Male cable to connect your local HDMI display device to the **HDMI Output** port.
4. Plug the power adapter that came with the VS1814T / VS1818T into an AC power source, then plug the power adapter cable into the splitter's Power Jack
5. (Optional) To edit the VS1814T / VS1818T system settings, connect a hardware / software controller to the RS-232 port.

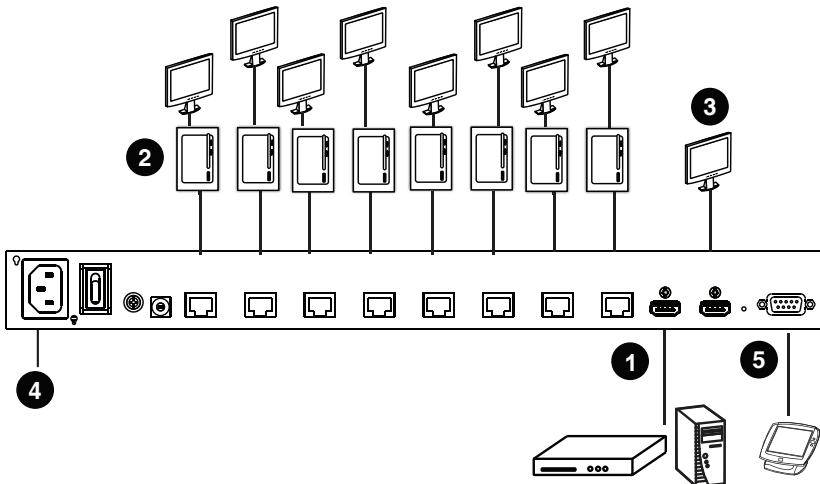

Chapter 3

Operation

Overview

The VS1814T / VS1818T offers easy and flexible EDID learning and mode selection through pushbuttons located in the unit's front and rear panels.

EDID Learn Pushbutton

The VS1814T / VS1818T can automatically learn a display's EDID by pressing the EDID Learn Pushbutton located on the front panel. Follow these steps:

1. Attach the video display/monitor that you want to use to the VS1814T / VS1818T **HDMI Output** port (See *Installation*, page 10).
2. To learn the EDID configuration of the video display/monitor, press and release the **EDID Learn** Pushbutton.
3. The EDID Learn LED flashes to indicate that the settings are being captured, then lights steady to indicate that EDID learning process is successful.

Note: The EDID Learn LED lights red to indicate that EDID learning process failed.

EDID Mode Selection

The VS1814T / VS1818T offers an easy and flexible EDID Mode selection method using the rear panel EDID Mode Switch.

Extended Display Identification Data (EDID) is a data format that contains a display's basic information and is used to communicate with the video source/system.

Simply press the **EDID Mode** pushbutton to toggle between the Default and other EDID Settings (0~7), as follows:

- ◆ **0 (Default)** – EDID is set to the ATEN default configuration
- ◆ **1 (Port 1)** – Implements the EDID of the connected display to Port 1, and passes it to the video source
- ◆ **2 (Auto)** - Implements the EDID of all connected displays. The VS1814T / VS1818T uses the best resolution for all displays
- ◆ **3 (Learn)** - Uses the EDID configuration acquired from the EDID Learning process.
- ◆ **4 ~ 7**- Reserved.

You can also select the EDID Mode using RS-232 commands. See *RS-232 Commands*, page 13 for details.

Installing the RS-232 Controller

In order to use the RS-232 serial interface to attach a high-end controller (such as a PC) to the VS1814T / VS1818T, use a serial cable such as a modem cable. The end connecting to the VS1814T / VS1818T should have a 9-pin male connector. Connect this to the serial interface on the rear of the VS1814T / VS1818T.

See *RS-232 Commands*, page 13 for details.

Chapter 4

RS-232 Commands

Overview

In order to use the RS-232 serial interface to attach a high-end controller (such as a PC) to the VS1814T / VS1818T, use a serial cable such as a modem cable. The end connecting to the VS1814T / VS1818T should have a 9-pin male connector. Connect this to the serial interface on the rear of the VS1814T / VS1818T. Refer to number 4 on the diagram on page 12.

Note: To configure the controller serial port, see page 10.

RS-232 Serial Interface

The VS1814T / VS1818T's built-in bi-directional RS-232 serial interface allows system control through a high-end controller, PC, and/or home automation / home theater software package.

Configuring the Serial Port

The controller's serial port should be configured as follows:

Baud Rate	19200
Data Bits	8
Parity	None
Stop Bits	1
Flow Control	None

Switch Port

The available formulas for Switch Port commands are as follows:

Switch Command + Output Command + Port Number + Control [Enter]

1. For example, to turn on output port 02, type the following:

sw o02 on

2. To turn off all output ports, type the following:

sw o* off

The following table shows the possible values for the Switch Port commands:

Command	Description
sw	Switch command
Output Command	Description
o	Output command
Port Number	Description
yy	01-08 port
l1	Local HDMI output port
*	All output ports (default)
Control	Description
on	Turn on the display (default)
off	Turn off the display

The following table shows the available command list:

Command	Output	Port	Control	Enter	Description
sw	o	yy l1 *	on	[Enter]	Turn on display for output port yy, local HDMI output port or all ports (yy: 01~08, l1, *).
sw	o	yy l1 *	off	[Enter]	Turn off display for output port yy, local HDMI output port or all ports (yy: 01~08, l1, *).

Note: 1. Each command string can be separated with a space.

2. The **Port Number** command string can be skipped, and the default value will be used.

CEC Commands

Consumer Electronics Control (CEC) allows interconnected HDMI devices to communicate and respond to one remote control. The formula for CEC mode selection commands is as follows:

**CEC Command + Output Command + Port Number + Control
[Enter]**

For example, to enable CEC function on output port 1, type the following:

cec o01 on [enter]

The following tables show the possible values and formats for the **Control** command:

Command	Description
cec	CEC control
Output Command	Description
o	Output command
Port number	Description
yy	01-08 port
l1	Local HDMI output port
*	All output ports (default)
Control	Description
off	Disable CEC (default)
on	Enable CEC

The following table shows the available command list:

Command	Output Port	Control	Enter	Description
cec	yy l1 *	off	[Enter]	CEC off for output port yy (default), local HDMI output port, or all ports (yy: 01~08, *).
cec	yy l1 *	on	[Enter]	CEC on for output port yy, local HDMI output port or all ports (yy: 01~08, *).

Note: 1. Each command string can be separated with a space.

2. The **Port Number** command string can be skipped, and the default value will be used.

Read Commands

View information from the device using the following command:

Read Command + Control [Enter]

The following tables show the possible values and formats for the **Control** command:

Command	Description
read	Reads and displays information from the VS1814T / VS1818T

Control	Description
version	Displays the firmware version of the VS1814T / VS1818T
(blank)	Displays the Port and CEC status (on/off)

The following table shows the available command list:

Command	Control	Enter	Description
read	version	[Enter]	Displays firmware version
read		[Enter]	Displays the Port and CEC status

Baud Rate Setting Commands

You can set up the VS1814T / VS1818T baud rate via RS-232. The formula for Baud Rate setting commands is as follows:

Baud + Baud Rate Setting value [Enter]

For example, to set the baud rate to 9600, input the following:

baud 9600 [Enter]

The following tables show the possible values for the **Control** string:

Command	Description
baud	Power On Detection command

Control	Description
9600	Uses 9600 baud rate
19200	Uses 19200 baud rate (default)
38400	Uses 38400 baud rate
57600	Uses 57600 baud rate

The following table shows the available command list:

Command	Control	Enter	Description
baud	9600	[Enter]	The VS1814T / VS1818T implements 9600 baud rate setting
baud	19200	[Enter]	The VS1814T / VS1818T implements 19200 baud rate setting (default)
baud	38400	[Enter]	The VS1814T / VS1818T implements 38400 baud rate setting
baud	57600	[Enter]	The VS1814T / VS1818T implements 57600 baud rate setting

Reset Commands

Reset the VS1814T / VS1818T to default factory settings using the following command:

Reset Command [Enter]

The following tables show the possible value for the **Control** command:

Command	Description
reset	Resets to factory default settings

The following table shows the available command list:

Command	Enter	Description
reset	[Enter]	Resets the VS1814T / VS1818T

Note: The Reset command reverts to the default baud rate, as well as switches on all output devices.

Verification

After entering a command, a verification message appears at the end of the command line as follows:

- ◆ **Command OK** - indicates that the command is correct and successfully performed by the device
- ◆ **Command incorrect** - indicates that the command has the wrong format and/or values.

Safety Instructions

General

- ◆ Read all of these instructions. Save them for future reference.
- ◆ Follow all warnings and instructions marked on the device.
- ◆ This product is for indoor use only.
- ◆ Do not place the device on any unstable surface (cart, stand, table, etc.). If the device falls, serious damage will result.
- ◆ Do not use the device near water.
- ◆ Do not place the device near, or over, radiators or heat registers.
- ◆ The device cabinet is provided with slots and openings to allow for adequate ventilation. To ensure reliable operation, and to protect against overheating, these openings must never be blocked or covered.
- ◆ The device should never be placed on a soft surface (bed, sofa, rug, etc.) as this will block its ventilation openings. Likewise, the device should not be placed in a built in enclosure unless adequate ventilation has been provided.
- ◆ Never spill liquid of any kind on the device.
- ◆ Unplug the device from the wall outlet before cleaning. Do not use liquid or aerosol cleaners. Use a damp cloth for cleaning.
- ◆ The device should be operated from the type of power source indicated on the marking label. If you are not sure of the type of power available, consult your dealer or local power company.
- ◆ The device is designed for IT power distribution systems with 230V phase-to-phase voltage.
- ◆ To prevent damage to your installation it is important that all devices are properly grounded.
- ◆ The device is equipped with a DC adapter. This is a safety feature.
- ◆ To help protect your system from sudden, transient increases and decreases in electrical power, use a surge suppressor, line conditioner, or un-interruptible power supply (UPS).
- ◆ Position system cables and power cables carefully; Be sure that nothing rests on any cables.

- ◆ Never push objects of any kind into or through cabinet slots. They may touch dangerous voltage points or short out parts resulting in a risk of fire or electrical shock.
- ◆ Do not attempt to service the device yourself. Refer all servicing to qualified service personnel.
- ◆ If the following conditions occur, unplug the device from the wall outlet and bring it to qualified service personnel for repair.
 - ◆ Liquid has been spilled into the device.
 - ◆ The device has been exposed to rain or water.
 - ◆ The device has been dropped, or the cabinet has been damaged.
 - ◆ The device exhibits a distinct change in performance, indicating a need for service.
 - ◆ The device does not operate normally when the operating instructions are followed.
- ◆ Only adjust those controls that are covered in the operating instructions. Improper adjustment of other controls may result in damage that will require extensive work by a qualified technician to repair.

Rack Mounting

- ◆ Before working on the rack, make sure that the stabilizers are secured to the rack, extended to the floor, and that the full weight of the rack rests on the floor. Install front and side stabilizers on a single rack or front stabilizers for joined multiple racks before working on the rack.
- ◆ Always load the rack from the bottom up, and load the heaviest item in the rack first.
- ◆ Make sure that the rack is level and stable before extending a device from the rack.
- ◆ Use caution when pressing the device rail release latches and sliding a device into or out of a rack; the slide rails can pinch your fingers.
- ◆ After a device is inserted into the rack, carefully extend the rail into a locking position, and then slide the device into the rack.
- ◆ Do not overload the AC supply branch circuit that provides power to the rack. The total rack load should not exceed 80 percent of the branch circuit rating.
- ◆ Make sure that all equipment used on the rack – including power strips and other electrical connectors – is properly grounded.
- ◆ Ensure that proper airflow is provided to devices in the rack.
- ◆ Ensure that the operating ambient temperature of the rack environment does not exceed the maximum ambient temperature specified for the equipment by the manufacturer
- ◆ Do not step on or stand on any device when servicing other devices in a rack.
- ◆ **Caution:** Slide/rail (LCD KVM) mounted equipment is not to be used as a shelf or a work space.



Technical Support

International

- ◆ For online technical support – including troubleshooting, documentation, and software updates: **<http://eservice.aten.com>**
- ◆ For telephone support, see *Telephone Support*, page iii:

North America

Email Support		support@aten-usa.com
Online Technical Support	Troubleshooting Documentation Software Updates	http://www.aten-usa.com/support
Telephone Support		1-888-999-ATEN ext 4988

When you contact us, please have the following information ready beforehand:

- ◆ Product model number, serial number, and date of purchase.
- ◆ Your computer configuration, including operating system, revision level, expansion cards, and software.
- ◆ Any error messages displayed at the time the error occurred.
- ◆ The sequence of operations that led up to the error.
- ◆ Any other information you feel may be of help.

Specifications

Function		VS1814T	VS1818T
Connectors	HDMI In	1 x HDMI Type A Female (Black)	
	HDMI Out	1 x HDMI Type A Female (Black)	
	HDBaseT Out	4 x RJ-45 Female	8 x RJ-45 Female
	Power Jack	1 x 3-prong AC socket	
	RS-232	1 x DB-9 Female (Black)	
Switches	EDID Mode	1 x 8-position switch	
	EDID Learn Mode	1 x pushbutton	
	F/W Upgrade	1 x semi-recessed button	
	Power	1 x Rocker	
LEDs	Power	1 (Green)	
	HDMI In	1 (Green)	
	HDMI Out	1 (Green)	
	EDID Learn	1 (Green / Red)	
	HDBaseT Out	4 (Green)	8 (Green)
Video		4k x 2k, 1080p @ 60Hz at 100m	
Power Consumption		120V / 20W; 230V / 23W	120V / 33W; 230V / 35W
Environment	Operating Temp.	0–50°C	
	Storage Temp.	-20–60°C	
	Humidity	0–80% RH, Non-condensing	
Physical Properties	Housing	Metal	
	Weight	2.10 kg	2.15 kg
	Dimensions (L x W x H)	43.24 x 26.11 x 4.40 cm	

Limited Warranty

IN NO EVENT SHALL THE DIRECT VENDOR'S LIABILITY EXCEED THE PRICE PAID FOR THE PRODUCT FROM DIRECT, INDIRECT, SPECIAL, INCIDENTAL, OR CONSEQUENTIAL DAMAGES RESULTING FROM THE USE OF THE PRODUCT, DISK, OR ITS DOCUMENTATION.

The direct vendor makes no warranty or representation, expressed, implied, or statutory with respect to the contents or use of this documentation, and especially disclaims its quality, performance, merchantability, or fitness for any particular purpose.

The direct vendor also reserves the right to revise or update the device or documentation without obligation to notify any individual or entity of such revisions, or update. For further inquiries, please contact your direct vendor.